



SmaRT BU-xH6R Base Unit

Manual

U078.1.0-SmaRTxH6R_BU-R

FCC Statements**15.19 – Two Part Warning**

This device complies with Part 15 of the FCC rules. Operation is subject to the following two conditions:

- (1) This device may not cause harmful interference and
- (2) This device must accept any interference received, including interference that may cause undesired operation.

15.21 – Unauthorized Modification

NOTICE: The manufacturer is not responsible for any unauthorized modifications to this equipment made by the user. Such modifications could void the user's authority to operate the equipment.

15.105(b) – Note:

Note: This equipment has been tested and found to comply with the limits for a Class B digital device, pursuant to part 15 of the FCC Rules. These limits are designed to provide reasonable protection against harmful interference in a residential installation. The equipment generates, uses and can radiate radio frequency energy and, if not installed and used in accordance with the instructions, may cause harmful interference to radio communications. However, there is no guarantee that interference will not occur in a particular installation. If this equipment does cause harmful interference to radio or television reception, which can be determined by turning the equipment off and on, the user is encouraged to try to correct the interference by one or more of the following measures:

- Reorient or relocate the receiving antenna.
- Increase the separation between the equipment and receiver.
- Connect the equipment into an outlet on a circuit different from that to which the receiver is connected.
- Consult the dealer or an experienced radio/TV technician for help.

Industry Canada Statement

This device complies with Canadian RSS-210.

The installer of this radio equipment must ensure that the antenna is located or pointed such that it does not emit RF field in excess of Health Canada limits for the general population; consult Safety Code 6, obtainable from Health Canada's website www.hc-sc.gc.ca/ewh-semt/pubs/radiation/radio_guide-lignes_direct-eng.php.

Cet appareil est conforme à la norme canadienne RSS-210.

L'installateur de cet équipement radio doit s'assurer que l'antenne est située ou dirigée de manière à ne pas émettre un champ RF excédant les limites imposées par Santé Canada pour la population en général; consultez le Code de sécurité 6, disponible sur le site web de Santé Canada www.hc-sc.gc.ca/ewh-semt/pubs/radiation/radio_guide-lignes_direct-eng.php.

Industry Canada Statement

This device complies with Industry Canada licence-exempt RSS standard(s). Operation is subject to the following two conditions: (1) this device may not cause interference, and (2) this device must accept any interference, including interference that may cause undesired operation of the device.

Le présent appareil est conforme aux CNR d'Industrie Canada applicables aux appareils radio exempts de licence. L'exploitation est autorisée aux deux conditions suivantes : (1) l'appareil ne doit pas produire de brouillage, et (2) l'utilisateur de l'appareil doit accepter tout brouillage radioélectrique subi, même si le brouillage est susceptible d'en compromettre le fonctionnement.

RoHS Compliance Statement

Cervis, Inc. complies with the requirements of **Restriction of Hazardous Substances (RoHS/WEEE) Specification** based on in-house practice and declaration of compliance from our vendors. For additional information concerning RoHS compliance, please contact Cervis, Inc. at:

CERVIS, Inc.

170 Thorn Hill Road • Warrendale, PA 15086
Phone: 724.741.9000 • Fax: 724.741.9001



This product may contain material that may be hazardous to human health and the environment. In compliance with EU Directive 2002/96/EC on Waste Electrical and Electronic Equipment (WEEE):

- ✓ Do not dispose of the product as unsorted municipal waste.
- ✓ This product should be recycled in accordance with local regulations. Contact local authorities for detailed information.
- ✓ This product may be returnable to the distributor for recycling. Contact your distributor for details.

IC Unlicensed Devices EIRP Statements for Removable Antennas

Part 1: Under Industry Canada regulations, this radio transmitter may only operate using an antenna of a type and maximum (or lesser) gain approved for the transmitter by Industry Canada. To reduce potential radio interference to other users, the antenna type and its gain should be so chosen that the equivalent isotropically radiated power (e.i.r.p.) is not more than that necessary for successful communication.

Conformément à la réglementation d'Industrie Canada, le présent émetteur radio peut fonctionner avec une antenne d'un type et d'un gain maximal (ou inférieur) approuvé pour l'émetteur par Industrie Canada. Dans le but de réduire les risques de brouillage radioélectrique à l'intention des autres utilisateurs, il faut choisir le type d'antenne et son gain de sorte que la puissance isotrope rayonnée équivalente (p.i.r.e.) ne dépasse pas l'intensité nécessaire à l'établissement d'une communication satisfaisante.

Part 2: This radio transmitter (LOBSRF-305) has been approved by Industry Canada to operate with the antenna type listed below with the maximum permissible gain and required antenna impedance for each antenna type indicated. Antenna types not included in this list, having a gain greater than the maximum gain indicated for that type, are strictly prohibited for use with this device.

Le présent émetteur radio (LOBSRF-305) a été approuvé par Industrie Canada pour fonctionner avec les types d'antenne énumérés ci-dessous et ayant un gain admissible maximal et l'impédance requise pour chaque type d'antenne. Les types d'antenne non inclus dans cette liste, ou dont le gain est supérieur au gain maximal indiqué, sont strictement interdits pour l'exploitation de l'émetteur.

This document is the property of Cervis, Inc. and cannot be copied, modified, e-mailed, or reproduced without the express prior written consent of Cervis, Inc.

Cervis, Inc. reserves the right to change this manual or edit, delete, or modify any information without prior notification.

Table of Contents

List of Figures	i
List of Tables	i
Cervix Inc. Safety Precautions	1
1.0 SmaRT BU-xH6R Base Unit	2
1.1 Base Unit Installation	4
1.2 Optional Antenna Extension Installation	6
1.3 BU-xH6R Wiring	7
1.4 External Protection Devices for Relay Contacts	8
1.5 Standard Configuration Output Check/Operating Mode Interlock	8
2.0 SmaRT BU-xH6R Specifications.....	10
3.0 SmaRT BU-xH6R Variations.....	11
4.0 BU-xH6R Troubleshooting Hints.....	13
5.0 BU-xH6R (BU-xH6R-EXT) Antenna and Cable List	14
Appendix A: Exposure to Radio Frequency Energy	15
Appendix B: Agency Identification Label Locations	15
Appendix C: Typical Handheld to Base Unit Communication.....	16
C1: BU-xH6R/PTO Remote Communication	16
C2: BU-xH6R/CB Remote Communication	18
C3: BU-xH6R/MCB Remote Communication	19
C4: BU-xH6R/PG Remote Communication	21
C5: BU-xH6R/XX-218 Remote Communication	22

List of Figures

Figure 1. BU-xH6R LEDs	2
Figure 2. Mounting Holes and Cable Connectors P1 and P2	4
Figure 3. 2.4GHz and 900MHz External Antenna Mounting Dimensions	5
Figure 4. Antenna Extension Kit Installation.....	6
Figure 5. Dual Connectors/Pin Numbers (enhanced).....	7
Figure 6. P1 and P2 Field Wiring Layout	7
Figure 7. Typical MOV and Suggested MOV Wiring Across the Contactor Coils	8
Figure 8. Agency Identification Label Locations	15
Figure 9. Associate/Dissociate Buttons	16
Figure 10. Associate and Dissociate Switch Actuations	18
Figure 11. MCB Switch Actuation for Associate and Dissociate	19
Figure 12. PG Switch Actuation for Associate and Dissociate	21
Figure 13. XX-218 Associate Mode.....	22
Figure 14. XX-218 Dissociate Mode.....	23

List of Tables

Table 1. Base Unit Output LED Interlock Indications	8
Table 2. SmaRT BU-xH6R Specifications	10
Table 3. SmaRT BU-xH6R Variations	11
Table 4. BU-xH6R Troubleshooting Hints.....	13
Table 5. Compatible BU-xH6R (BU- xH6R-EXT) External Antenna Details	14
Table 6. Compatible BU-xH6R P1 and P2 Cables	14

Definitions/Notes

Associate

SmaRT configuration method using a series of specific remote unit button presses to establish a communication link between a SmaRT handheld and a SmaRT base unit.

CAN

Controller Area Network: a standard high-speed serial network interface used in a variety of industrial and vehicular applications.

DSSS

Direct sequence spread spectrum; an advance wireless communication technology.

Disassociate/Dissociate

Dissolution of all established communication links between handhelds and a base unit.

IP65

IEC (International Electrotechnical Commission) rating that classifies the level of protection provided by an enclosure.

IP (international protection)

6 (dust tight)

5 (water jetted from any direction on the enclosure shall have no harmful effects)

PTO

Push to Operate: Command broadcast only while a button is depressed. The command ends when the button is released.

BU-xH6R

Base unit with six relay outputs controlled by a SmaRT handheld remote. Each SmaRT BU-xH6R can communicate with up to eight handhelds.

SmaRT 9nn or 2nn Remote Control System

SmaRT system consisting of one SmaRT base unit and from one to eight SmaRT remote control units. The system operates in the 900MHz range (9nn) or 2.4GHz (2nn) and has some defined number (nn) of outputs.

For instance, a SmaRT 904 Remote Control System operates in the 900MHz range, and a maximum of four outputs can be controlled by the remote.

Line of Sight (aka Direct-Line-of-Sight)

Type of communication between transceivers, or a transmitter and a receiver, where the pathway between the two units must be clear of obstacles.

TX/RX

Transmit/Receive

MOV (Metal Oxide Varister)

Discrete electronic component commonly used to divert excessive current. A protection device used to suppress noise that can have an undesired effect on equipment and systems.

Snubber (Snubber Circuit)

Electrical circuit used to suppress electrical spikes (transients) by diverting excess current around the protected device.

RS-232

Low-speed serial interface used for configuration of the base unit.

Cervis Inc. Safety Precautions

- ✓ ***Read and follow all instructions.***
- ✓ ***Failure to abide by Safety Precautions may result in equipment failure, loss of authority to operate the equipment, and personal injury.***
- ✓ ***Use and maintain proper wiring. Follow equipment manufacturer instructions. Improper, loose, and frayed wiring can cause system failure, equipment damage, and intermittent operation.***
- ✓ ***Changes or modifications made to equipment not expressly approved by the manufacturer will void the warranty.***
- ✓ ***Owner/operators of the equipment must abide by all applicable Federal, State, and Local laws concerning installation and operation of the equipment. Failure to comply could result in penalties and could void user authority to operate the equipment.***
- ✓ ***Make sure that the machinery and surrounding area is clear before operating. Do not activate the remote control system until certain that it is safe to do so.***
- ✓ ***Turn off the handheld remote and remove power from the base unit before attempting any maintenance. This will prevent accidental operation of the controlled machinery.***
- ✓ ***Power can be removed from the Base Unit by detaching the 12-pin cables from the base unit connectors P1 and P2, or by removing the source power from the circuit.***
- ✓ ***Use a damp cloth to keep units clean. Remove mud, concrete, dirt, etc. after use to prevent obstructing or clogging the buttons, levers, wiring, and switches.***
- ✓ ***Do not allow liquid to enter the handheld or base unit enclosures. Do not use high pressure equipment to clean the handheld remote or base unit.***
- ✓ ***Disconnect the radio base unit before welding on the machine. Failure to disconnect the base unit may result in destruction of or damage to the base unit.***
- ✓ ***Keep high-energy RF devices away from handheld remotes. Activation of high-power communication radios, for instance, in close proximity to the handheld remotes can result in interference and “false” circuit activation.***
- ✓ ***Operate and store units only within the specified operation and storage temperatures defined in the Specifications section of this document.***

1.0 SmaRT BU-xH6R Base Unit

The SmaRT BU-xH6R Base Unit features six Form C relay outputs. Each Form C relay contact can switch up to 8 amperes at 250VAC or VDC. Using Direct Sequence Spread Spectrum (DSSS) wireless technology at 900MHz or 2.4GHz, the base unit provides a robust link with a handheld in congested radio environments at extended ranges. All controlled apparatus connections and power to the base unit are made using two cables with keyed, heavy duty 12-pin connectors through which output signals are also ported. Five status/diagnostic LEDs shown in Figure 1 below are used to determine the state of the unit.

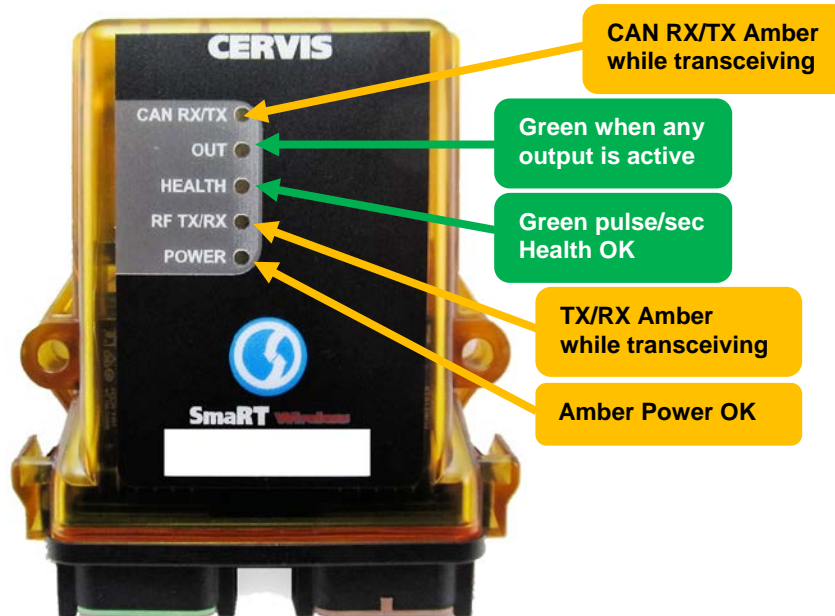

Figure 1. BU-xH6R LEDs

BU-xH6R Input Power

Input power depends upon the type of BU-xH6R used:

- BU-xH6R-xxx-HVU accepts input voltage of 100 to 240VAC @ 47 to 440Hz, or 120 to 370VDC
- BU-xH6R-xxx-LVD accepts 7–32VDC, and
- BU-xH6R-xxx-LVA accepts 7–28VAC, 50/60 Hz

The –HVU power option uses a universal converter that can accept either high-voltage AC or DC input. The converter is not polarity sensitive.

The –LVD option is polarity sensitive to enhance low input voltage behavior and to prevent resets occurring due to sagging battery voltage when an engine is started.

The –LVA option permits operation using readily available step-down control voltage transformers for power.

An optional CAN interface feature is available for networking multiple base units for more complex control applications. Contact Cervis for more information.

An RS-232 interface is available for use with SmaRT Connect. Due to pin limitations, it is not available if the CAN option is selected.

BU-xH6R Base Unit Features

(See Table 3. *SmaRT BU-xH6R Variations* for a complete listing.)

- Capable of communicating to up to eight SmaRT handheld remotes
- License Free Frequency, Direct Sequence Spread Spectrum Technology for 900MHz @ 10mW or 2.4GHz @ 100mW RF Power
- CAN interface optional
- Internal antenna standard. External antenna optional
- 300m (1000ft.) range*
- Six independent relay outputs, each with a single Form C contact
- 8A maximum switching per contact at 250VAC or VDC
- Rugged compact high-impact polymer, weatherproof design IP65 enclosure
- Three available input voltage platforms
- Five viewable external diagnostic LEDs
- RS-232 interface for SmaRT Connect configuration.

**with external antenna*

1.1 Base Unit Installation

CAUTION



Make sure the machine on which the base unit is to be attached is disabled during installation.

Use the configuration diagrams supplied by Cervis to guide you in mounting the base unit and connecting your wiring harness cables. Mounting of the base unit is left much to your discretion with the following guidelines:

- Before installing, make sure that the configuration diagrams supplied with the system are available. Keep them where they are available at all times.
- Make sure the wiring harness cables (Figure 5) are at hand.
- Always mount the receiver away from any intense radio or electric disturbance sources.
- Make sure the mount is secure. Mount the unit where you have enough room for your wiring harness connections.
- If exposed to rain or low pressure water jets, Cervis recommends installing as shown with the connectors down. And, a drip-loop formed with the cables is a good-practice recommendation.

CAUTION



The base unit enclosure and connectors are NOT rated for high pressure washing. Doing so could damage the base unit or connectors.

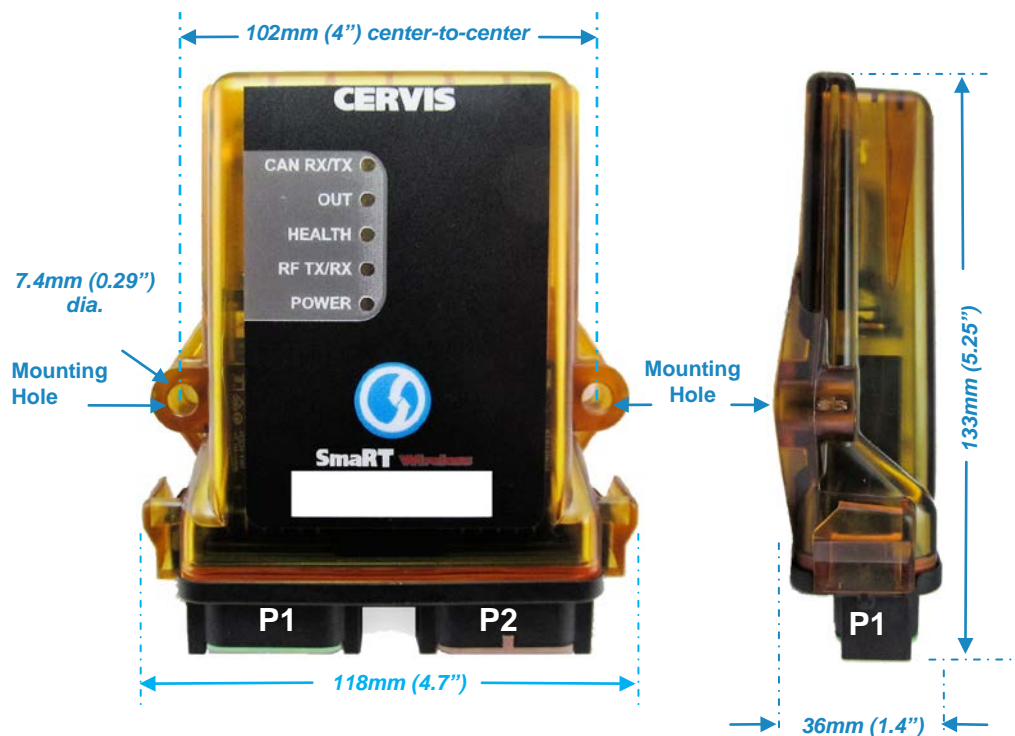

Figure 2. Mounting Holes and Cable Connectors P1 and P2

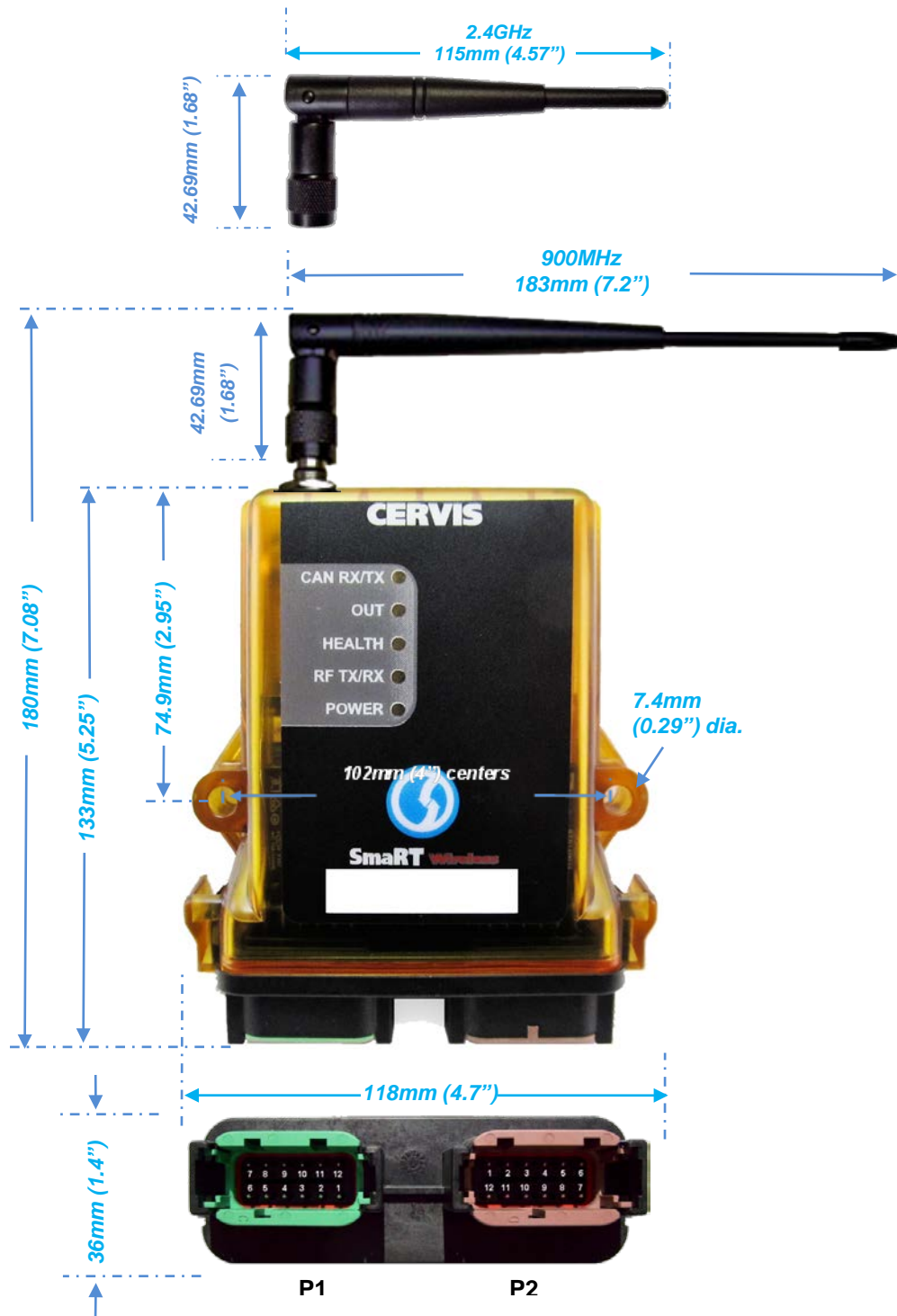

Figure 3. 2.4GHz and 900MHz External Antenna Mounting Dimensions

1.2 Optional Antenna Extension Installation

Both the 10 ft. and 3 ft. antenna extension cables are compatible with 2.4GHz and 900MHz antennas. The antenna example shown in Figure 4 is a 2.4GHz antenna.

Make sure the antenna is located in clear line-of-sight of the remote.

1. Loosen and remove extension cable nut to allow the antenna ferrule to push through a mounting hole (user discretion).
2. Rethread the nut to secure the ferrule to the device.
3. Attach cable extension to the BU-xH6R.
4. Attach the antenna to the extension ferrule.



Figure 4. Antenna Extension Kit Installation

1.3 BU-xH6R Wiring

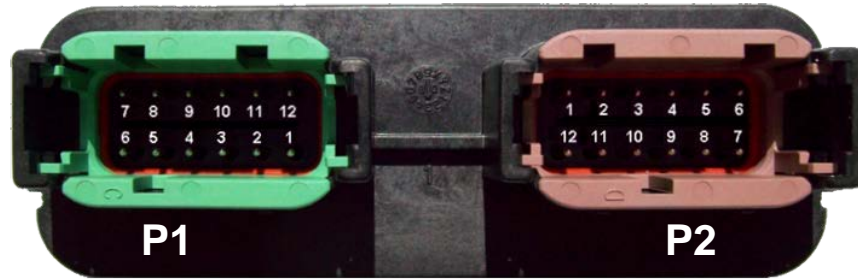

Figure 5. Dual Connectors/Pin Numbers (enhanced)

CAUTION If the supply voltage of a base unit drops below a minimum volt level even momentarily—the unit will reset. Minimum supply voltages are:

- 7VDC for a BU-xH6R-xxx-LVD
- 7.0VAC for a BU-xH6R-xxx-LVA
- 90VAC or 100VDC for a BU-xH6R-xxx-HVU

If the supply voltage drops below minimum input volts for a consistent period of time, the LEDs (including the TX/RX LEDs if transceiving) will dim and flicker. These circumstances are symptoms of a battery or power source that cannot sustain the present current load. This situation should be remedied as soon as possible.

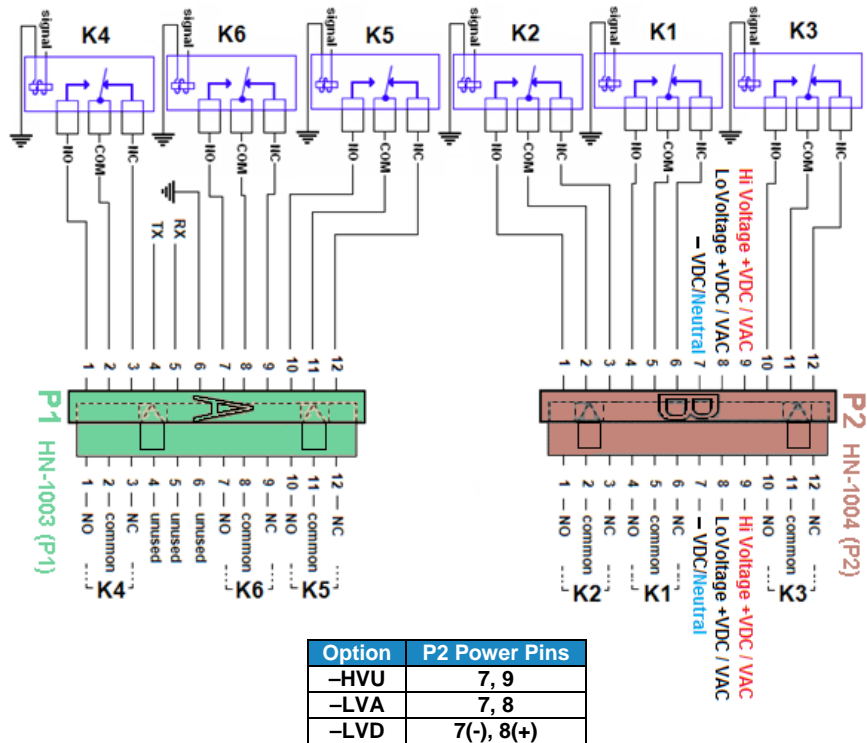

Figure 6. P1 and P2 Field Wiring Layout

1.4 External Protection Devices for Relay Contacts

The BU-xH6R, depending on the model may have internal snubbing circuits to protect the relay contacts. (See Table 3, AC Sup.) Each snubber consists of a 47Ω resistor in series with a 0.1 μF capacitor across each relay contact. However, the internal snubbers may not be adequate for all loads and applications. An MOV, or Metal Oxide Varistor, is a protection device used to suppress high transient voltages that can cause deterioration of the relay contacts, especially when switching inductive loads such as solenoids or relay coils. They protect circuits against excessive transient voltages by clamping the voltage to a safe level and dissipating the unwanted energy. To provide proper protection, the MOV must have a voltage rating and an energy dissipation rating appropriate to the application. Other devices, such as power Zener diodes or R-C snubbers, may be necessary depending on the application and whether the switched circuits are AC or DC.

When using contactors or solenoids with SmaRT systems, it is advisable to use external protective devices by connecting them across the coils as shown in the examples below using MOVs.

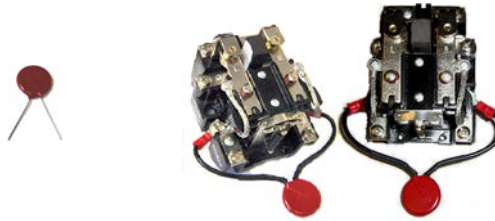

Figure 7. Typical MOV and Suggested MOV Wiring Across the Contactor Coils

In some applications, the internal snubbers may not be desired. (See Table 3, AC Sup.) The – NOS option can be specified to omit them. However, this can leave the contacts vulnerable to switching transients and arcing. Contact Cervis Customer Service for assistance in choosing appropriate contact protection.

1.5 Standard Configuration Output Check/Operating Mode Interlock

An interlock is present in the default configuration for outputs that prevents an output from activating if the adjacent button on the hand-held is pressed at the same time as the intended button. Once the remote is associated to the base unit (see Appendix C), outputs when properly wired respond and are indicated by the base unit Output LED as shown in below.

Table 1. Base Unit Output LED Interlock Indications

Handheld Remote Momentary Action	Command	BU-xH6R Result
Press and hold function corresponding to Output 1	Activate Output K1	Output K1 active, Output LED lights and remains lit until the PTO Output 1 is released.
Press and hold function corresponding Output 2	Activate Output K2	Output K2 active, Output LED lights and remains lit until the PTO Output 2 is released.
Press and hold function corresponding Output 1 and Output 2	Operating Mode Interlock	Operating Mode Interlock prevents K1 and K2 output activity. Output LED is unlit.
Press and hold function corresponding Output 3	Activate Output K3	Output K3 active, Output LED lights and remains lit until the PTO Output 3 is released.
Press and hold function corresponding Output 4	Activate Output K4	Output K4 active, Output LED lights and remains lit until the PTO Output 4 is released.

Base Unit

Handheld Remote Momentary Action	Command	BU-xH6R Result
Press and hold function corresponding Output 3 and Output 4	Operating Mode Interlock	Operating Mode Interlock prevents K3 and K4 output activity. Output LED is unlit.
Press and hold function corresponding Output 5	Activate Output K5	Output K5 active, Output LED lights and remains lit until the PTO Output 5 is released.
Press and hold function corresponding Output 6	Activate Output K6	Output K6 active, Output LED lights and remains lit until the PTO Output 6 is released.
Press and hold function corresponding Output 5 and Output 6	Operating Mode Interlock	Operating Mode Interlock prevents K5 and K6 output activity. Output LED is unlit.

✓ **Note:** The default configuration can be modified to suit the needs of the application if necessary.

2.0 SmaRT BU-xH6R Specifications

Table 2. SmaRT BU-xH6R Specifications

Item	Description		
Power	Operating Power	5W max.	
	RF power	10mW @ 900MHz; 100mW @ 2.4GHz	
Vin	BU-xH6R-xxx-HVU	100-240VAC @ 47-440Hz, or 120-370VDC	
	BU-xH6R-xxx-LVD	7-32VDC	
	BU-xH6R-xxx-LVA	7-28VAC	
Environment	Operating temp.	-25°C to 60°C (-13°F to 140°F)	
	Storage temp.	-40°C to 85°C (-40°F to 185°F)	
	Humidity	0 to 100%	
	Vibration/Shock	IEC60068-2-6 10Hz to 150Hz @ 1.0g peak acceleration 10.0g peak shock acceleration	
Radio	Frequency	906-924MHz; 2405-2480MHz	
	License	No license required	
	Modulation	DSSS	
	Antenna	Internal	
Enclosure	Dimensions	mm: 133 x 118 x 36; Inch: 5.24 x 4.65 x 1.42	
	Weight	340g; 0.75 lbs.	
	Durability	High Impact Polymer	
Indicators	CAN TX/RX	Red	CAN active transmit
		Green	CAN active receive
	Out	Lit	Active output
	Health	Green Pulse/Sec.	OK
	TX/RX	Green	Receive
		Red	Transmit
Power	Amber	OK	
	Red/green	Fault	
Outputs	Contacts	Six (6) Form C Each rated 8A max. switching @ 250VAC or VDC. 100mA min. @ 5VDC. 48A max. total output	
CAN Option	Protocol	SAE J1939	
RS-232	Settings	19,200 bits/sec, N, 8, 1 (Not available with CAN option.)	

3.0 Smart BU-xH6R Variations

Common Features:

No Display; Channel Type are all Form C Relays; Number of channels each is 6.

Table 3. Smart BU-xH6R Variations

Model	Freq	RF Pwr	Input Pwr	Antenna	Serial Port	AC sup	Smart Connect
BU-9H6R-INT-LVD	900MHz	10mW	7-32VDC	Internal	RS-232	Yes	Yes
BU-9H6R-INT-LVD-CAN	900MHz	10mW	7-32VDC	Internal	CAN	Yes	Yes
BU-9H6R-INT-LVD-NOS	900MHz	10mW	7-32VDC	Internal	RS-232	No	Yes
BU-9H6R-INT-LVD-NOS-CAN	900MHz	10mW	7-32VDC	Internal	CAN	No	No
BU-9H6R-INT-LVA	900MHz	10mW	7-28VAC	Internal	RS-232	Yes	Yes
BU-9H6R-INT-LVA-CAN	900MHz	10mW	7-28VAC	Internal	CAN	Yes	No
BU-9H6R-INT-LVA-NOS	900MHz	10mW	7-28VAC	Internal	RS-232	No	Yes
BU-9H6R-INT-LVA-NOS-CAN	900MHz	10mW	7-28VAC	Internal	CAN	No	No
BU-9H6R-INT-HVU	900MHz	10mW	100-240VAC	Internal	RS-232	Yes	Yes
BU-9H6R-INT-HVU-CAN	900MHz	10mW	100-240VAC	Internal	CAN	Yes	No
BU-9H6R-INT-HVU-NOS	900MHz	10mW	100-240VAC	Internal	RS-232	No	Yes
BU-9H6R-INT-HVU-NOS-CAN	900MHz	10mW	100-240VAC	Internal	CAN	No	No
BU-9H6R-EXT-LVD	900MHz	10mW	7-32VDC	External	RS-232	Yes	Yes
BU-9H6R-EXT-LVD-CAN	900MHz	10mW	7-32VDC	External	CAN	Yes	No
BU-9H6R-EXT-LVD-NOS	900MHz	10mW	7-32VDC	External	RS-232	No	Yes
BU-9H6R-EXT-LVD-NOS-CAN	900MHz	10mW	7-32VDC	External	CAN	No	No
BU-9H6R-EXT-LVA	900MHz	10mW	7-28VAC	External	RS-232	Yes	Yes
BU-9H6R-EXT-LVA-CAN	900MHz	10mW	7-28VAC	External	CAN	Yes	No
BU-9H6R-EXT-LVA-NOS	900MHz	10mW	7-28VAC	External	RS-232	No	Yes
BU-9H6R-EXT-LVA-NOS-CAN	900MHz	10mW	7-28VAC	External	CAN	No	No
BU-9H6R-EXT-HVU	900MHz	10mW	100-240VAC	External	RS-232	Yes	Yes
BU-9H6R-EXT-HVU-CAN	900MHz	10mW	100-240VAC	External	CAN	Yes	No
BU-9H6R-EXT-HVU-NOS	900MHz	10mW	100-240VAC	External	RS-232	No	Yes
BU-9H6R-EXT-HVU-NOS-CAN	900MHz	10mW	100-240VAC	External	CAN	No	No
FUTURE RELEASE							
BU-2H6R-INT-LVD	2.4GHz	100mW	7-32VDC	Internal	RS-232	Yes	Yes
BU-2H6R-INT-LVD-CAN	2.4GHz	100mW	7-32VDC	Internal	CAN	Yes	Yes
BU-2H6R-INT-LVD-NOS	2.4GHz	100mW	7-32VDC	Internal	RS-232	No	Yes
BU-2H6R-INT-LVD-NOS-CAN	2.4GHz	100mW	7-32VDC	Internal	CAN	No	No
BU-2H6R-INT-LVA	2.4GHz	100mW	7-28VAC	Internal	RS-232	Yes	Yes
BU-2H6R-INT-LVA-CAN	2.4GHz	100mW	7-28VAC	Internal	CAN	Yes	No
BU-2H6R-INT-LVA-NOS	2.4GHz	100mW	7-28VAC	Internal	RS-232	No	Yes
BU-2H6R-INT-LVA-NOS-CAN	2.4GHz	100mW	7-28VAC	Internal	CAN	No	No
BU-2H6R-INT-HVU	2.4GHz	100mW	100-240VAC	Internal	RS-232	Yes	Yes
BU-2H6R-INT-HVU-CAN	2.4GHz	100mW	100-240VAC	Internal	CAN	Yes	No
BU-2H6R-INT-HVU-NOS	2.4GHz	100mW	100-240VAC	Internal	RS-232	No	Yes
BU-2H6R-INT-HVU-NOS-CAN	2.4GHz	100mW	100-240VAC	Internal	CAN	No	No
BU-2H6R-EXT-LVD	2.4GHz	100mW	7-32VDC	External	RS-232	Yes	Yes
BU-2H6R-EXT-LVD-CAN	2.4GHz	100mW	7-32VDC	External	CAN	Yes	No
BU-2H6R-EXT-LVD-NOS	2.4GHz	100mW	7-32VDC	External	RS-232	No	Yes
BU-2H6R-EXT-LVD-NOS-CAN	2.4GHz	100mW	7-32VDC	External	CAN	No	No
BU-2H6R-EXT-LVA	2.4GHz	100mW	7-28VAC	External	RS-232	Yes	Yes
BU-2H6R-EXT-LVA-CAN	2.4GHz	100mW	7-28VAC	External	CAN	Yes	No

Model	Freq	RF Pwr	Input Pwr	Antenna	Serial Port	AC sup	SmaRT Connect
BU-2H6R-EXT-LVA-NOS	2.4GHz	100mW	7-28VAC	External	RS-232	No	Yes
BU-2H6R-EXT-LVA-NOS-CAN	2.4GHz	100mW	7-28VAC	External	CAN	No	No
BU-2H6R-EXT-HVU	2.4GHz	100mW	100-240VAC	External	RS-232	Yes	Yes
BU-2H6R-EXT-HVU-CAN	2.4GHz	100mW	100-240VAC	External	CAN	Yes	No
BU-2H6R-EXT-HVU-NOS	2.4GHz	100mW	100-240VAC	External	RS-232	No	Yes
BU-2H6R-EXT-HVU-NOS-CAN	2.4GHz	100mW	100-240VAC	External	CAN	No	No

4.0 BU-xH6R Troubleshooting Hints

Table 4. BU-xH6R Troubleshooting Hints

Problem	Indication
Power LED not active	<ul style="list-style-type: none"> ✓ Is input power present? ✓ Check input power polarity for VDC. Indicates internal fuse blown.
Power LED Red or Green	Indicates an internal component failure.
TX/RX not active	<ul style="list-style-type: none"> ✓ Check for obstructions preventing line-of-sight transmission. ✓ Check that the handheld remote is active. ✓ Re-associate the handheld remote to the base unit.
Health LED blinking Amber	Indicates an internal problem.
Health LED blinking Red	Over-temperature indicated.
Out LED not active	<ul style="list-style-type: none"> ✓ Check that the handheld LEDs are active when the buttons are pushed. ✓ Are interlocked output buttons being simultaneously pressed?
Unit reset	Indicates the supply voltage momentarily dropped below the minimum operating voltage. This is a symptom that the power source may not be able to sustain the present current load. <ul style="list-style-type: none"> ✓ Check power source.
LEDs dim and flickering	Indicates the supply voltage has dropped below the minimum operating voltage for a significant period of time. This is a symptom that the power source may not be able to sustain the present current load. <ul style="list-style-type: none"> ✓ Check power source.

CAUTION



Push-To-Operate means that the outputs under control should only change states when the appropriate button of the handheld is pressed, and then only for the duration of time that particular output button is pressed. Any unexpected motion that occurs when pressing the output control buttons of the handheld must be investigated.

Should a jerkiness of motion occur while constantly pressing an output button, immediately stop operation. Check the Out LED and the other diagnostic LEDs of the BU-xH6R for any indication of a problem.

Be aware that even if the diagnostic LEDs of the handheld and base unit do not indicate a problem, one may be present and further troubleshooting steps may be needed.

If a problem is found, do not operate the Smart System until the problem is resolved.

5.0 BU-xH6R (BU-xH6R-EXT) Antenna and Cable List

Table 5. Compatible BU-xH6R (BU- xH6R-EXT) External Antenna Details

Part	Cervis BIN
900MHz IS BAND Swivel Antenna	BB3-06
2.4GHz Swivel Antenna, +3dBi	BB3-07
3 ft. antenna extension cable	J5-02
10 ft. antenna extension cable	J5-02
10 ft. antenna cable (J5-02) and external antenna (BB3-06)	EXT-10-900
3 ft. antenna cable (J5-07) and external antenna (BB3-06)	EXT-3-900

✓ **Note:** Only the antenna recommended by Cervis, Inc. is to be used with the SmaRT base unit.

Table 6. Compatible BU-xH6R P1 and P2 Cables

Wiring Harness	Part Number
Cable P1	HN-1003 (for P1)
Cable P2	HN-1004 (for P2)
Single Cable, Dual Connector	HN-1006 (colored wires)

Appendix A: Exposure to Radio Frequency Energy

SmaRT handheld remote units contain radio transceivers. When active, handheld remotes send out radio frequency (RF) energy through its internal antenna.

For optimal performance and to ensure that human exposure to RF energy does not exceed the recommended guidelines, always follow these instruction and precautions: When using the handheld remote, hold the remote so that the top buttons are away from the body in the direction of the base unit. Keep the remote when in use at least 15mm (5/8 inch) away from the body, and only use carrying cases, belt clips, or holders that are approved by Cervix, Inc.

A SmaRT base unit when active sends out radio frequency (RF) through its external antenna. Base units using an external antenna should be mounted to ensure the antenna is at least 20cm away from the human body. Only the external antennas recommended by Cervix, Inc. are to be used (see Table 5).

Appendix B: Agency Identification Label Locations

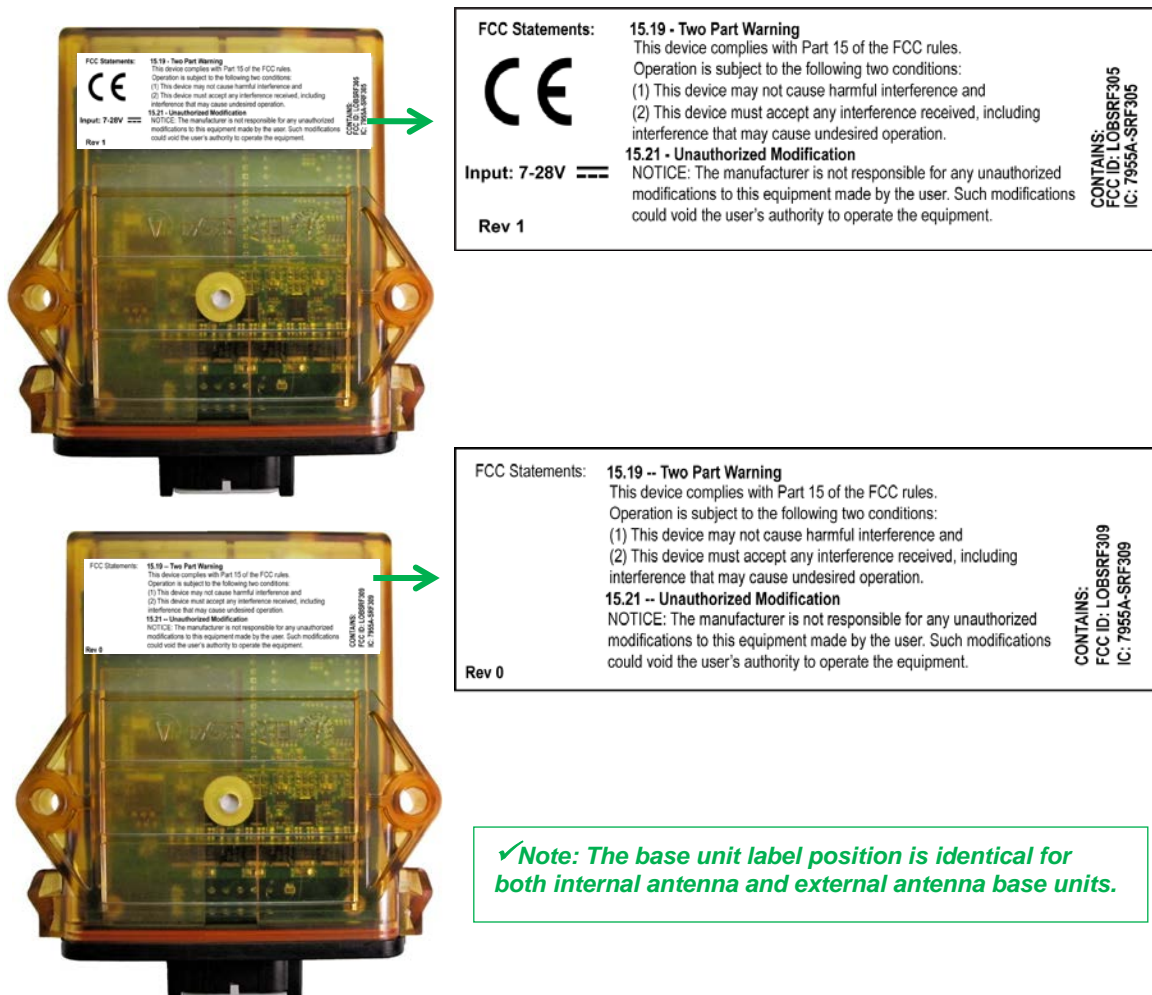

Figure 8. Agency Identification Label Locations

Appendix C: Typical Handheld to Base Unit Communication

Handheld remote and base unit communications are established at Cervis before shipping when systems are ordered. However, it may be necessary to establish or re-establish communication between a remote and a base unit at some point. The Associate procedure is used to do this.

A standard SmaRT System consists of one handheld remote and one base unit. Each base unit is capable of communicating with up to eight handheld remotes. Each handheld must first establish a communications link with the base unit before the base unit will recognize the handheld unit. This process is called Associate.

In some cases it may become necessary to break the communication link between the handheld and the BU-xH6R. This process is called Dissociate. *Be aware that when a handheld is dissociated from a base unit, all communication links to that particular base unit are erased from the base unit memory!* For instance, a particular BU-xH6R is associated to Handheld Remotes 1 through 5. Remote 2 dissociates—breaks the communication link—from the base unit. All five handheld remotes are removed from the base unit memory. The Associate procedure must be used by any handheld that now needs to control that BU-xH6R.

The following Associate and Dissociate procedures are general methods of associating or dissociating Cervis handheld remotes to the BU-xH6R. Custom systems may have different Associate methods unique to the custom system design.

C1: BU-xH6R/PTO Remote Communication

To Associate

The base unit and handheld must be OFF prior to attempting to associate. Base unit and PTO 2, 4, and 6 button handheld association is established using the following steps:

1. Remove power from the base unit and turn off (PTO – time out) the hand-held device.
2. Stand near the base unit in unobstructed, clear line-of-sight with the handheld in hand.
3. Simultaneously press and hold the Associate (B1) and Dissociate (B2) buttons. RX and ER light.
4. Continue to hold both buttons until TX and RX light steady.
5. When TX and RX light, release B1 and B2. ER and BA light.

✓ Note: If the next button press is not immediately performed (approximately 2sec.), all LEDs flash and the Associate procedure is aborted. The process must be started anew to establish the communication link.

6. Immediately press and hold the Associate button (B1). All LEDs light.
7. TX begins to slowly blink. Continue to hold B1.
8. Apply power to the base unit.

The handheld and base unit begin to establish a communication link while the Associate button is held. Once the process is complete, all LEDs light briefly and then go out.

9. Release the Associate button. The SmaRT System is ready for use with that particular handheld remote.

Figure 9. Associate/Dissociate Buttons

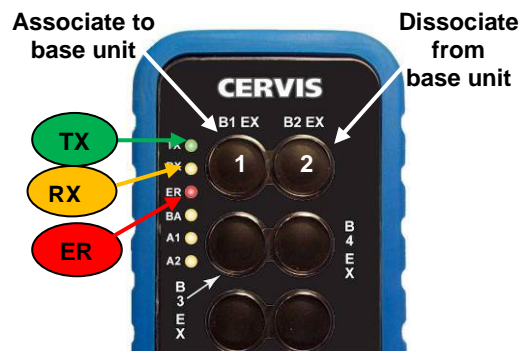

To Dissociate

In some circumstances it may become necessary to break the communication link, or dissociate a base unit and a PTO handheld remote.

CAUTION



Using the following steps will break all previously established handheld remote links. It will be necessary to perform the Association Procedure (Heading 0 above) using each handheld to re-establish communication links with a base unit.

1. Remove power from the base unit.
2. Stand near the base unit in line of sight with the handheld in your hand.
3. Press and hold both Associate (Button 1) and Dissociate (Button 2; see Figure 9). RX and ER light.
4. Continue to hold both buttons until TX and RX light steady.
5. When TX and RX light, release B1 and B2. ER and BA light.

✓ **Note:** *If the next button press is not performed within the two second interval all LEDs flash and the procedure is aborted. The process must be started anew to break the communication link.*

6. Press and hold the Dissociate button B2. (See Figure 9 above.) All LEDs light.
7. TX begins to slowly blink. Continue to hold B2.
8. Apply power to the base unit while continuing to hold the Dissociate button.

The base unit and all previously linked handhelds begin to Dissociate communication links. Once the process is complete, all LEDs light briefly and then go out.

9. Release the Dissociate button.

The SmaRT base unit will not communicate with any handheld remote units. A handheld remote must use the Association Procedure (Heading 0 above) to re-establish a communication link with the base unit.

C2: BU-xH6R/CB Remote Communication

CAUTION



To prevent inadvertent movement of the machine, be sure to remove power from the Base Unit before attempting to Associate or Dissociate.

The console remote must be **OFF** and the base unit must have power removed before the Association process can be started.

✓ **Note:** The Machine Stop button must be in the UP position prior to activating and using the console remote.

To Associate (see Figure 10)

1. Stand near the base unit with the console remote OFF and power removed from the base unit (P1 and P2 cables detached from the base unit, or the power source is removed.)
2. Twist to pull UP the red Stop button on the remote.
3. Hold the Associate switch SW13 UP. While holding the Associate switch UP, activate the console remote by holding switch SW12 UP (ON). Continue to hold both switches.
4. Observe the LEDs. When TX begins to blink, power up the base unit while continuing to hold SW13 and SW12. When TX, RX, ERR, and BAT light solid, release SW13 and SW12.

A successful association is indicated when LEDs **TX** and **RX** are rapidly blinking in unison.



Figure 10. Associate and Dissociate Switch Actuations

To Dissociate (see Figure 11)

The CB remote must be **OFF** and the base unit must have power removed before the Dissociation process can be started.

✓ **Note:** The Machine Stop button must be in the UP position prior to activating and using the console remote.

1. Stand near the base unit with the console remote OFF and power removed from the base unit (P1 and P2 cables detached from the base unit, or the power source is removed.)
2. Twist to pull UP the red Stop button on the remote.
3. Hold the Associate switch SW13 DOWN. While holding the Associate switch DOWN, activate the console remote by holding switch SW12 UP (ON). Continue to hold both switches.
4. Observe the LEDs. When TX begins to blink, power up the base unit while continuing to hold SW13 and SW12. When TX, RX, ERR, and BAT light solid, release SW13 and SW12.

✓ **Note:** Be aware that all remote associations to the base unit are now broken.

C3: BU-xH6R/MCB Remote Communication

CAUTION



To prevent inadvertent movement of the machine, be sure to remove power from the Base Unit before attempting to Associate or Dissociate.

To Associate (see Figure 11)

The MCB remote must be **OFF** and the base unit must have power removed before the Association process can be started.

✓ **Note:** The Machine Stop button must be in the UP position prior to activating and using the console remote.

1. Stand near to the base unit with the remote **OFF** and **power removed** from the base unit (disconnect P1 and P2 or turn the source power OFF).
2. Release the **STOP** button on the MCB handheld by pulling up.
3. Push and hold **S1 UP** and then press the **Power ON** button. All four LEDs light solid.
4. Observe the LEDs. When TX begins to blink, power up the base unit while continuing to hold S1 and the Power button. When all four LEDs light solid, release S1 and Power Button.

A successful Association is indicated when LEDs TX and RX are rapidly blinking in unison.



Figure 11. MCB Switch Actuation for Associate and Dissociate

To Dissociate (see Figure 11)

The MCB remote must be **OFF** and the base unit must have power removed before the Dissociation process can be started.

✓ **Note:** The Machine Stop button must be in the UP position prior to activating and using the console remote.

1. Stand near to the base unit with the remote **OFF** and **power removed** from the base unit (disconnect P1 and P2 or turn the source power OFF).
2. Release the **STOP** button on the MCB handheld by pulling up.
3. Push and hold **S1 DOWN** and then press the **Power ON** button. All four LEDs light solid.
4. Observe the LEDs. When TX begins to blink, power up the base unit while continuing to hold SW1 and the Power button. When all four LEDs light solid, release SW1 and the pushbutton.

✓ **Note:** Be aware that all remote associations to the base unit are now broken.

C4: BU-xH6R/PG Remote Communication

CAUTION



To prevent inadvertent movement of the machine, be sure to remove power from the Base Unit before attempting to Associate or Dissociate.

To Associate (See Figure 12).

The PG remote must be **OFF** and the base unit must have power removed before the Association process can be started.

✓ **Note:** The Machine Stop button must be in the UP position prior to activating and using the console remote.

1. Stand near to the base unit with the remote **OFF** and **power removed** from the base unit (disconnect P1 and P2 or turn the source power OFF).
2. Release the **STOP** button on the PG handheld by twisting and pulling up.
3. Push and hold **SW1 UP** and **SW7 UP**. All four LEDs light solid.
4. Observe the LEDs. When TX begins to blink, power up the base unit while continuing to hold SW1 and SW7. When all four LEDs light solid, release SW1 and SW7.

A successful association is indicated when LEDs TX and RX are rapidly blinking in unison.



Figure 12. PG Switch Actuation for Associate and Dissociate

To Dissociate (see Figure 12)

The PG remote must be **OFF** and the base unit must have power removed before the Dissociation process can be started.

✓ **Note:** The Machine Stop button must be in the UP position prior to activating and using the console remote.

1. Stand near to the base unit with the remote **OFF** and **power removed** from the base unit (disconnect P1 and P2 or turn the source power OFF).
2. Release the **STOP** button on the PG handheld by twisting and pulling up.
3. Push and hold **SW1 UP** and **SW7 DOWN**. All four LEDs light solid.
4. Observe the LEDs. When TX begins to blink, power up the base unit while continuing to hold SW1 and SW7. When all four LEDs light solid, release SW1 and SW7.

✓ **Note:** Be aware that all remote associations to the base unit are now broken.

C5: BU-xH6R/XX-218 Remote Communication

CAUTION



To prevent inadvertent movement of the machine, be sure to remove power from the Base Unit before attempting to Associate or Dissociate.

To Associate (see Figure 13)

Associate mode is used to establish the communications link between the 18-button handheld remote and base unit on a 1-to-1 basis.

To Associate:

- there must be a clear line of sight between the handheld and the base
- the handheld must be near the base unit—within 6’—and
- both units must be OFF (powered down).

The 18-button handheld is turned off by pressing its OFF button when the unit is ON, or by allowing the unit to time-out. Off is indicated when none of the LEDs are active when any function button is pressed. The SmaRT base unit is safely powered down by disconnecting the power source from the unit.



Figure 13. XX-218 Associate Mode

✓ **Note:** *Observe LED states while performing the following procedure.*

1. Remove power from the base unit and turn off the handheld.
2. Stand near the base unit with the handheld in a clear, unobstructed line-of-sight.
3. Press and hold **button 2**, then press and hold **button 1**. Both buttons should be held simultaneously.
4. Wait until the amber LED2 goes out. Release the two buttons being held.
5. Press and release B16. The GREEN LED1 and the RED LED3 turn **ON**.
6. Power up the base unit.

If the Association is successful, the AMBER LED2 will flash. If communications are not established following the Associate procedure, please repeat until communication between the handheld and base unit is achieved.

To Dissociate (see Figure 14)



Figure 14. XX-218 Dissociate Mode

✓ **Note:** *Observe LED states while performing the following procedure.*

1. Remove power from the base unit and turn off the handheld.
2. Stand near the base unit with the handheld in a clear, unobstructed line-of-sight.
3. Press and hold **button 2**, then press and hold **button 1**. Both buttons should be held simultaneously.
4. Wait until the amber LED2 goes out. Release the two buttons being held.
5. Press and release B17. The GREEN LED1 and the RED LED3 turn **ON**.
6. Power up the base unit.

If dissociation is successful, green LED1 on the handheld remote will continually flash (TX) indicating that the handheld and the base unit are not communicating

Visit our Web site at: www.cervisinc.com

© 2014 Cervis Inc. All rights reserved. Content is subject to change without notice.